



■ Catálogo
2021



Aplicaciones Principales



ESCALERAS



SUPERFICIES VERTICALES



BORDES



PAVIMENTOS

Características Principales



Mango pivotante - puede limpiar por debajo de 20cm de altura



Arnés para la batería



Robusto mango de aluminio 6061-t5



Potente motor a 360 rpm



Imparable - Resiste más de 7kg de fuerza descendente



Mango telescópico

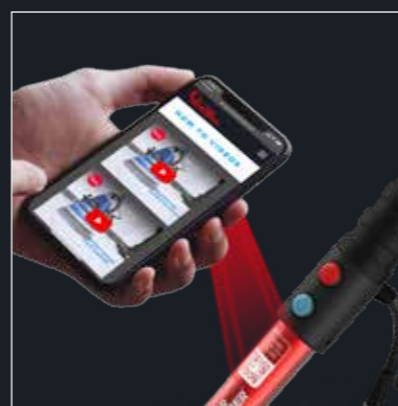

Scanea para descubrir tutoriales



Fácil y rápido cambio de cepillos

MADE IN BRITAIN



1. MS3004N Asa de agarre
2. MS3114C Mochila completa
3. MSGREY12V Carcasa del motor con conexión en forma de Y
4. MS7003 Plataforma para discos
5. MS1041 Cepillo de servicio medium
6. MS1053 Pad microfibra de 20cm
7. MS1066 Pad blanco de 20cm
8. MS1062 Pad verde de 20cm
9. MS1064 Pad rojo de 20cm
10. MS1046 Porta-pad
11. MS1580 Cargador de batería
12. MS4005 Paquete de tornillos universales



DESCRIPCIÓN	CÓDIGO
Kit mango largo Mango telescópico 120cm - 240cm Recomendado para la limpieza normal de paredes altas y para la limpieza ocasional del suelo.	M3L
Kit mango medio Mango telescópico 70cm - 140cm Recomendado para la limpieza normal de suelos y para la limpieza ocasional de paredes.	M3M
Kit mango corto Mango Fijo 38 cm. Recomendado para una limpieza a la altura máxima de ojos.	M3S

Información de packaging

M3S & M3M

Caja
Peso - 8kg

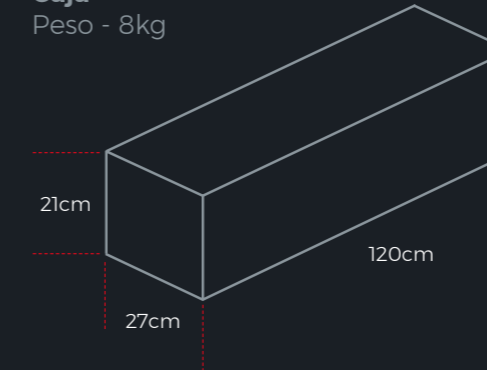

M3L

Caja
Peso - 8kg

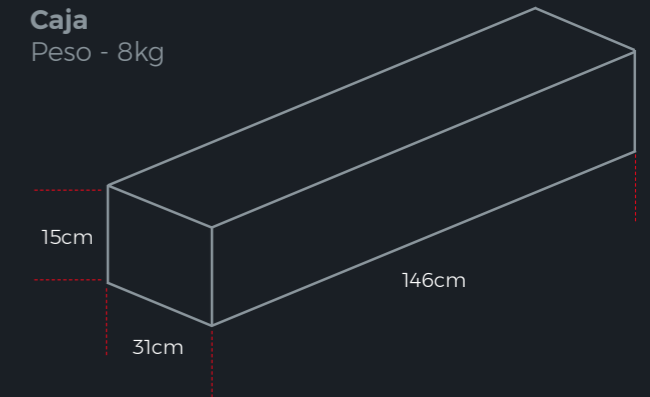

Palet = 36 máquinas
Peso - 298kg





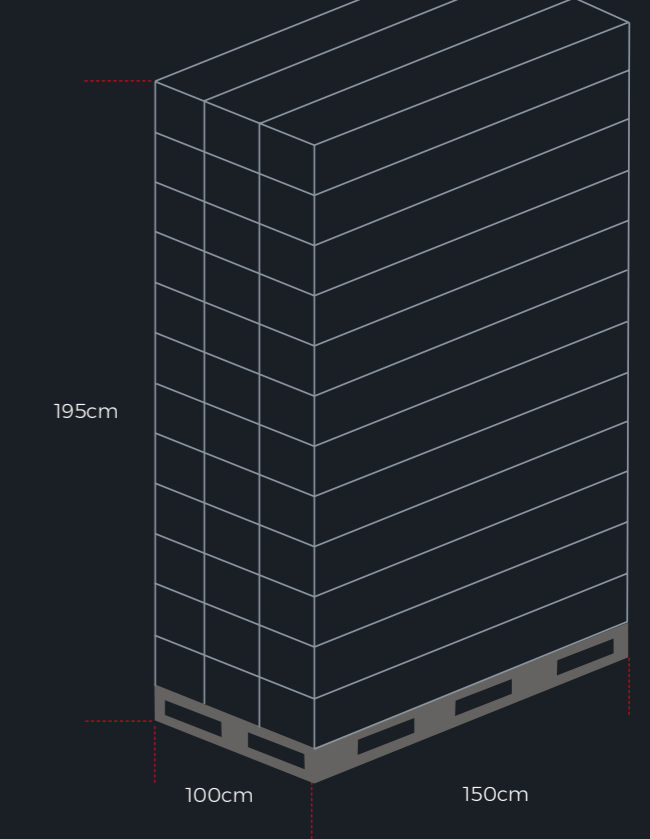









Palet = 36 máquinas
Peso - 298kg





DESCRIPCIÓN	CÓDIGO
 Cepillo para trabajos delicados	MS1038
 Cepillo para trabajos agresivos	MS1039P
 Cepillo para azulejos Bestseller	MS1039TC
 Cepillo para trabajos medios	MS1041
 Cepillo de puntas	MS1044
 Cepillo para escaleras Bestseller	MS1049
 Cepillo abrasivo para escaleras	MS1049T

DESCRIPCIÓN	CÓDIGO
 Porta-pad (plato de tracción) x 1	MS1046
 Pad microfibra multiuso de 22cm x 1	MS1053
 Pad melamina x 5 Bestseller	MS1070
 Pad negro decapante de 20cm x 5	MS1060
 Pad verde de 20cm x 5	MS1062
 Pad rojo de 20cm x 5	MS1064
 Pad azul de 20cm x 5	MS1068
 Pad blanco pulido en seco de 20cm x 5	MS1066
 Pad decapante de alto rendimiento de 20cm x 10	MS1069
 Pad cristalizador x 2	MS1071
 Pad twister blanco reacondicionante de 20cm x 2	211763
 Pad twister amarillo brillo de 20cm x 2	211760
 Pad twister verde mantenimiento y brillo de 20cm x 2	211759

Accesorios y producto químico

DESCRIPCIÓN	CÓDIGO
 Mango telescópico de 125cm	MS4003-L
 Mango telescópico de 75cm	MS4003-M
 Mango fijo de 38cm	MS4003-S
 Kit de protección contra salpicaduras	MS3080
 Producto químico cristalizante	MS1072
 Bolsa de transporte	MS3065

 WALL DOCK

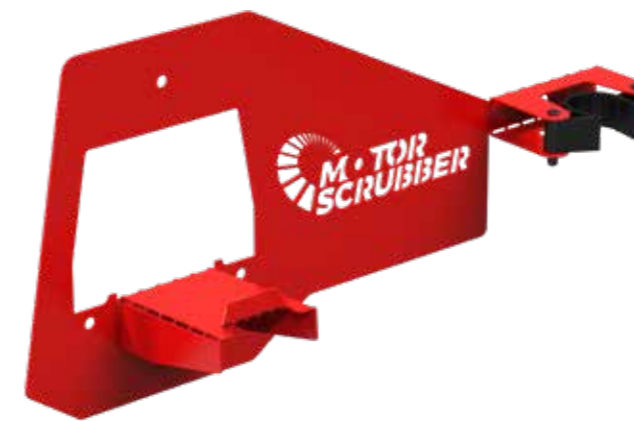

MotorScrubber Soporte pared

Almacena ordenadamente tu sistema de limpieza en la pared.

Permite almacenar su MotorScrubber JET3 y BLADE como parte del sistema DMT.



DESCRIPCIÓN	CÓDIGO
Motorscrubber Wall Dock - Soporte de pared	MS1073

Recambio recomendado















DESCRIPCIÓN	CÓDIGO
 Batería y mochila completa con cable en espiral (sin cargador)	MS3114C
 Carcasa del motor con conexión en forma de Y	MSGREY12V
 Kit de herramientas (contiene todos los tornillos)	MS4005
 Cable de batería en espiral de 110cm	MS3009
 Cargador EU	MS1580EU
 Interruptor On/Off	MSS11

OTROS RECAMBIOS (No se recomienda almacenarlos)

DESCRIPCIÓN	CÓDIGO
 Batería de 12 V	12V7A
 Empuñadura de goma	MSS103
 Carcasa del interruptor completa	MSS402



DESCRIPCIÓN	CÓDIGO
 Carcasa del motor con conexión en forma de Y	MSGREY12V
 Empuñadura de goma	MSS103
 Cable en espiral de 3 núcleos con racor rápido metálico hembra	MSJ01
 Cable recto de 3 núcleos con racor rápido metálico macho	MSJ03B
 Bomba de inyección	MSJ06
 Botella	MSJ09
 Tapón de la botella	MSJ10
 Válvula de retención de 4mm x 1	MSJ11
 Filtro de salida de la manguera	MSJ15B
 Interruptor rojo de los cepillos	MSJ25
 Interruptor azul de la bomba	MSJ26
 Cargador EU	MS1580EU



BARCELONA

C/ Rec del Moli n° 33
Pol. Ind. Moli de les Planes
SANT CELONI
08470 BARCELONA

Tel. 938 675 092

Fax. 938 673 665

comercial@rcmiberica.es

MADRID

C/ Blas Cabrera, C1
Parque Empresarial La Garena
ALCALÁ DE HENARES
28806 MADRID

Tel. 918 809 294

Fax. 918 837 735

Distribuidor Motorscrubber autorizado

7 DISTRIBUCIONS

Maquinària de neteja

Miquel Andreu Munar Bibiloni

C/ Sebastià Vila, 14

07650 - Santanyí

T. 696 906 771

comercial@7distribucions.com

www.7distribucions.com



comercial@motorscrubberclean.es

www.motorscrubberclean.es

